

vigil *anti slip*



haagh



protection bv

next level safety



Haagh Protection BV

Haagh Protection has actively promoted safe working since 1981. In over 35 years, we experienced time and time again that a proper and safe workplace increases the pleasure people take in their work. Furthermore, a safe work environment helps to reduce absenteeism as it prevents incidents and increases work productivity and quality. People spend their energy on carrying out their work, rather than worrying about tripping, slipping and other hazardous incidents. A proper and safe workplace is therefore an investment that offers an excellent return on investment!



Haagh Protection is specialised in various best-in-class quality products, which share the common characteristic of creating a safe and pleasant workplace. We happily conclude that today, many people choose quality over low prices as they acknowledge the added value of sustainable products with excellent quality guarantees and long lifecycles.

This brochure offers you an impression of the VIGIL® anti-slip product range that offers unparalleled quality.

Safety with anti-slip

Occupational incidents do unfortunately still happen every single day. One third of these incidents is caused by slipping, tripping or falling. Not only do these incidents cause personal distress and injury, they also lead to steep costs. The loss of production, medical expenses and specific company expenses such as finding and paying for a replacement on top of the paid sick leave, as well as additional OHS costs, are quite expensive. Furthermore, incidents often lead to reputational damage, significant fines or both.

Consequently, preventing these incidents from happening by implementing the right safety measures saves considerable amounts of money. Research has shown that a sustainable reduction of the risk of workplace incidents is highly profitable for both companies and society as a whole. Absenteeism drops, the work atmosphere improves, and so does productivity.

As the exclusive distributor in Europe of VIGIL® products, Haagh Protection offers you their high-end solutions that solve the problem of slippage. VIGIL® is a distinguished Australian brand that delivers professional anti-slip products across the globe, helping industrial environments, the oil & gas industry, offshore environment and the mining industry to increase their safety.

The VIGIL® anti-slip products are used in situations where nothing is left to chance and safety and quality are key. This sustainable material derives its superior quality and long lifecycle from its specific manufacturing method, offering excellent long-term return on investment.

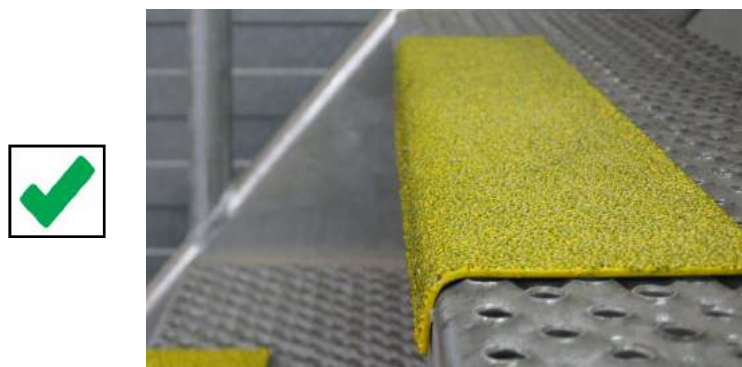



Vigil productinformatie

Elements:

VIGIL® creates anti-slip elements manufactured in a factory where environmental conditions are strictly controlled. This leads to a product with an exceptional and constant quality.

Experience has shown that coating products used at workplaces are rarely applied under ideal circumstances, for instance because of time pressure and temperature differences. After all, the floor must be returned to productivity as soon as possible. Products of which the quality varies per batch and the varying sorts of surfaces on which they are attached – which are almost never entirely clean and grease-free during product application – have proven to make it exceptionally hard to apply an anti-slip coating that proves sustainable over the course of time. Delamination (dislodging) of anti-slip coatings can therefore hardly be prevented, leaving no alternative than costly regular replacements.

Metal elements:

As a base material, VIGIL® offers two standard types of undergrounds for its metal anti-slip products:

- A metal Colorbond® element with a 1.2mm thickness. Colorbond® is a metal fitted with a zinc/aluminium layer on both sides, on which a primer and a yellow enamel paint is applied. This offers excellent resistance against corrosion, in particular because of the self-repairing zinc layer. This solution suffices in most cases.

- If the materials will be exposed to sea water or an acidic environment, the stainless steel 316 with 1.2mm thickness is the most suitable base material. This underground of this 1.2mm thick plate material creates sufficient rigidity to prevent delamination to a maximum extent while limiting and remaining sufficiently thin to prevent any tripping hazard. Upon your request, the metal VIGIL® elements are also available with aluminium as its base material.

Production process:

Op de metalen basis van het element wordt met speciale lijmsorten een flexibele anti-delaminatie-laag aangebracht die bestaat uit een speciaal weefsel; hierop is een epoxy harslaag aangebracht met daarop de zeer harde silicium-carbide antislip laag. Het product wordt vervolgens in een geconditioneerde omgeving met een bijna 0% vochtigheidsgehalte en een omgevingstemperatuur van 25° C. gedurende lange tijd uitgehard. Door de maakwijze ontstaat een optimale balans tussen antislip, afvloeiing en goede reinigbaarheid van de werkplek.

No delamination:

Delamination - the dislodging of coating layers - caused by the different expansion coefficient of the various layers and intensive walking over the anti-slip layers, is one of the most significant challenges in creating sustainable materials. The flexible fabric layer applied onto the VIGIL® products in a highly conditioned setting solved this problem. VIGIL® therefore offers a 10 year warranty on the delamination risk!



COMMERCIAL



INDUSTRIAL



OFFSHORE

Chemical durability and cleaning:

When applied in environments that are frequently contaminated, floors must be cleaned regularly. The VIGIL® material has excellent characteristics under these circumstances: they can be perfectly cleaned with brushing machines and high-pressure cleaners; even with hot water. The anti-delamination properties ensure that this product can be cleaned often and long without experiencing any problems.

The anti-slip coating is resistant against prolonged exposure to most chemical substances, and solvents in particular. This coating itself does of course not contain any solvents itself, as standard petrochemical products would deteriorate the surface otherwise.

Sustainability with silicon carbide:

The sustainable anti-slip effect is attained by applying silicon carbide granules (SiC), also known as carborundum or artificial diamond. This is an exceptionally hard material used for purposes such as grinding, polishing and manufacturing diamond drills. The hardness of any material is determined by its resistance to permanent mechanical deformation. The scale used most often to determine the hardness of materials is the Mohs' scale of mineral hardness. After diamond (with 10.0 Mohs), Carborundum (with 9.2 to 9.5 Mohs) is the hardest material known to man. This makes for a highly sustainable, abrasion-resistant anti-slip coating.

ANTI-SLIP grades:

Depending on the level of contamination inherent to the work performed at the location, a mesh grade can be chosen for the silicon carbide granules.

VIGIL® anti-slip offers three grades:

- **commercial**
 - **industrial**
 - **offshore**
-

COMMERCIAL grades:

For situations with limited contamination such as warehouses, laboratories or canteens requiring sustainable and solid anti-slip conditions, the commercial grade suffices in nearly all common situations.

The combination of the best anti-slip properties with proper cleanability, excellent chemical resistance and a high mechanical resistance makes VIGIL® a distinguished product with an exceptionally long lifecycle.

INDUSTRIAL grades:

The Industrial grade is applied at workplaces in manufacturing sites and commercial space with medium contamination levels. The silicon carbide granules used are less coarse, which makes them rougher in situations with medium contamination levels.

OFFSHORE grades:

In heavily contaminated areas, often seen in the offshore, oil, dredging and mining industries, the Offshore grade is the default pick. The structure with coarse silicon carbide granules ensures that elements these Offshore grade elements continue to provide sufficient anti-slip protection even in heavily contaminated areas, before cleaning is required.

“A PRODUCT WITH EXCELLENT LONG-TERM RETURN ON INVESTMENT.”



Vigil Stair & Bull Nosings

Falling down stairs often leads to significant physical and traumatizing consequences. Weather influences or the presence of excess quantities of oils, fats and other contaminants increase the chance of incidents exponentially.

The Vigil anti-slip stair-nosing (re)profiles the most important part of the steps by increasing the contact surface to protect against often occurring hazards caused by frequent usage (polished step edges), worn or defective stairs and spots that are exposed to weather conditions or spilled liquids.

Stair nosings

90° angle

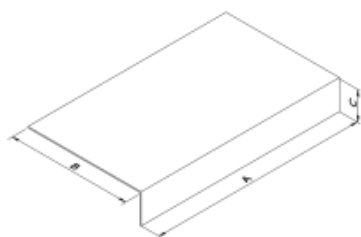

Bull nosings

8 mm (0,3") radius

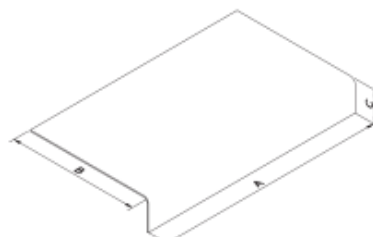
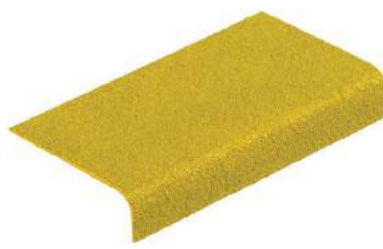

Standaard afmetingen:

- A: 450 mm (17.7")
600 mm (23.6")
750 mm (29.5")
900 mm (35.4")
1200 mm (47.2")
- B: 80 mm (3.15")
130 mm (5.12")
180 mm (7.10")
220 mm (8.70")
- C: 20 mm (0.8")

prices and sizes available upon request

Standard grades:

Commercial, Industrial, Offshore.

LOW
HEAD ROOM



Vigil Ladder Rung Covers

Vigil antislip ladder rung covers eliminate the risk of slipping from ladders by increasing and roughening the surface of the rungs. Furthermore, they increase the friction coefficient and visibility.

Various weather influences, contamination and even viscous or corrosive liquids do not diminish the anti-slip properties of the ladder rung cover or the lifecycle of the product in any way.

Do not expose people to the risk of slippery rungs and apply this unique product yourself, or have our experts do it for you.

Square profile

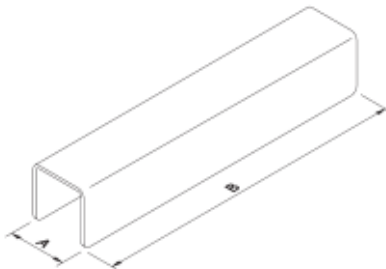

Tubular profile

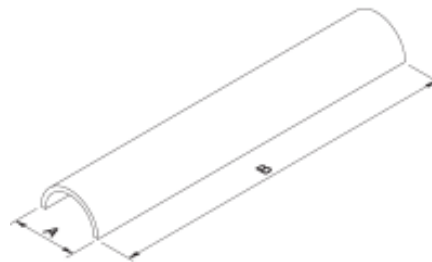

Standard sizes:

A: 20 mm (0.8")
25 mm (1.0")
30 mm (1.2")
35 mm (1.4")

B: 200 mm (7.9")
300 mm (11.8")
450 mm (17.7")

Prices and sizes available upon request

Standard grade:

Light Industrial



Vigil Metal Deck

Surfaces that are or appear level can be just as dangerous as stairways. Poor lighting, tears, bumps and the presence of spilled liquids or exposure to other contaminants exponentially increase the chances of tripping, falling or slipping, resulting in injuries and loss of time and productivity.

Vigil metal deck eliminates the hazards of falling, slipping and tripping. Furthermore, this product is also highly resistant against mechanical stress, enabling forklift traffic for instance, and can be applied on a very large spectrum of surfaces such as concrete, grated surfaces and chequer plates.

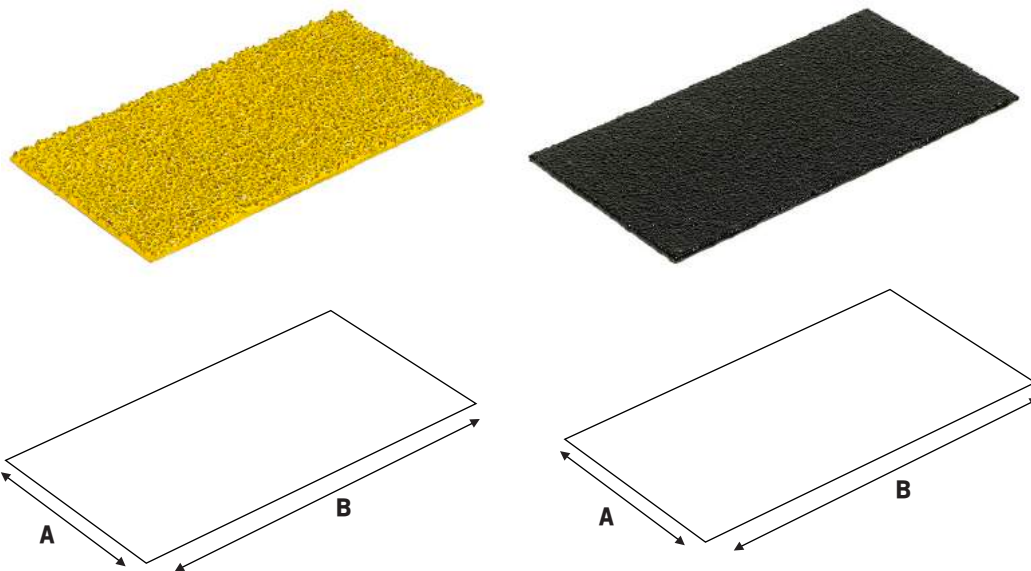

Standard sizes:

A: 200 mm (7.9")
600 mm (23.6")

B: 450 mm (17.7")
600 mm (23.6")
750 mm (29.5")
900 mm (35.4")
1200 mm (47.2")

Prices and sizes available upon request

Standard grades:
Commercial, Industrial, Offshore



**ESCAPE
ROUTE**



**ESCAPE
ROUTE**

Vigil Deck Mark

Adding a Deck Mark to an anti-slip element adds an extra dimension to the safety characteristic of Vigil anti-slip. At any location where a quick and safe evacuation may save the lives of staff members, Vigil anti-slip Deck Mark is an absolute necessity.

Each Vigil element can be equipped with a Deck Mark that indicates, for instance, escape routes or another message in letters of internationally recognized symbols. The anti-slip elements with the Deck Mark are placed exactly where people escaping a hazardous situation look: on the ground. The added symbols or texts do of course not influence the product properties in any way.



Vigil Vinyl Deck

A new floor made from cement, concrete or vinyl may seem safe, but can cause just as much damage as an old, worn floor. Just leave some water or another liquid on it, and the hazards increase drastically.

Vinyl deck is primarily suited for curved or hollow surfaces (for instance tank vehicles or silos) or surfaces with a minimal mechanical load. It is easy to permanently apply this product on each surface with an adhesive. The material can be easily cut to size and whether it is used in an industrial environment or in wet areas such as changing rooms or canteens; it will not discolour or delaminate.

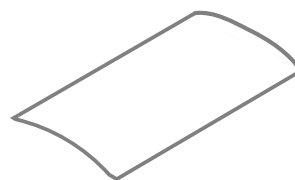
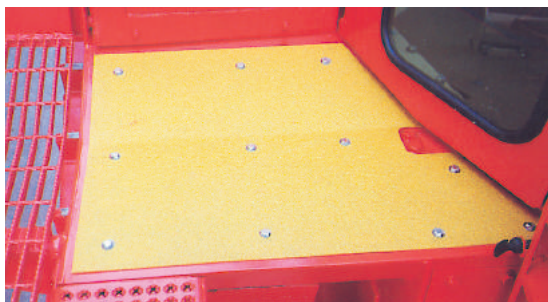

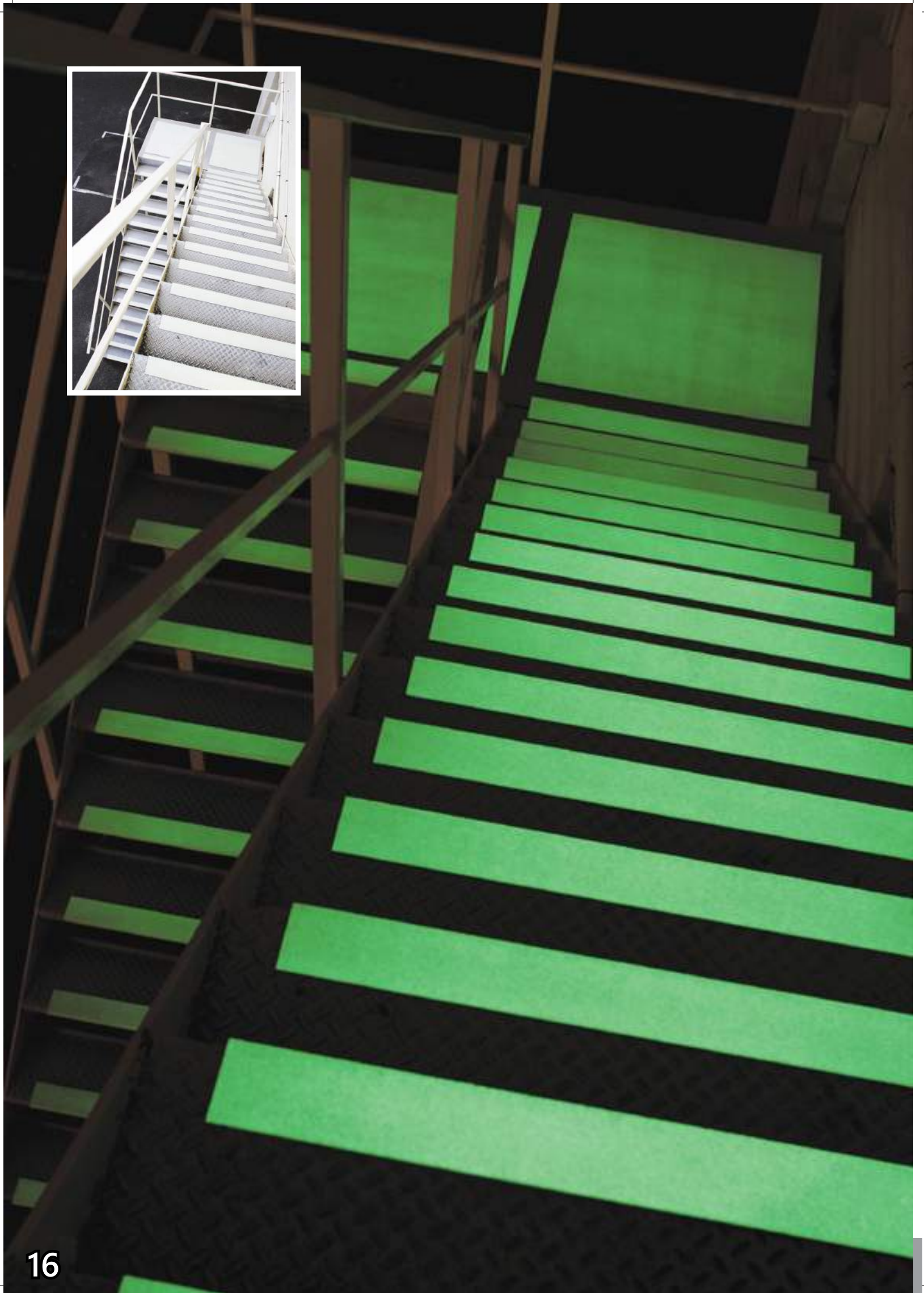
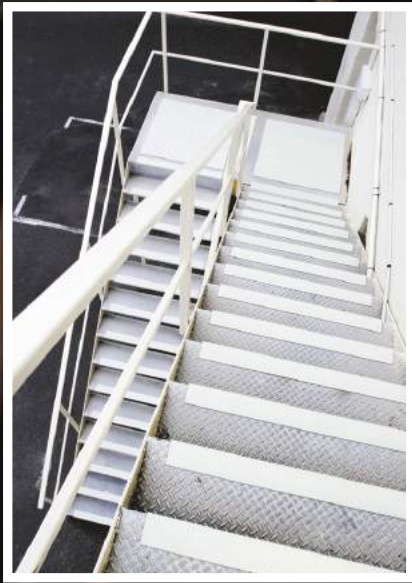

Vigil Deck light

Deck Light is a product family in which a photo-luminescent layer (glow in the dark) is integrated. Deck Light elements glow in the dark or when there is no lighting due to a power outage. In an otherwise dark area, these elements light up and remain clearly visible for a long time. This makes the Deck Light perfect to create escape routes and walking routes with guaranteed visibility and a rough anti-slip surface. Nearly all Vigil products are available in Deck Light editions.

Deck Light is the most ideal product to add extra safety to escape routes when there is no lighting or when smoke develops.

- o Made from high-grade material
- o Afterglow time 8 to 12 hours
- o No power, battery packs or batteries required
- o Easily applied with mounting kit or screws
- o Tailored products possible

Standard sizes:

A: 200 mm (7.9")
600 mm (23.6")

B: 450 mm (17.7")
600 mm (23.6")
750 mm (29.5")
900 mm (35.4")
1200 mm (47.2")

Prices and sized available upon request

Standard grades:

Commercial, Industrial, Offshore

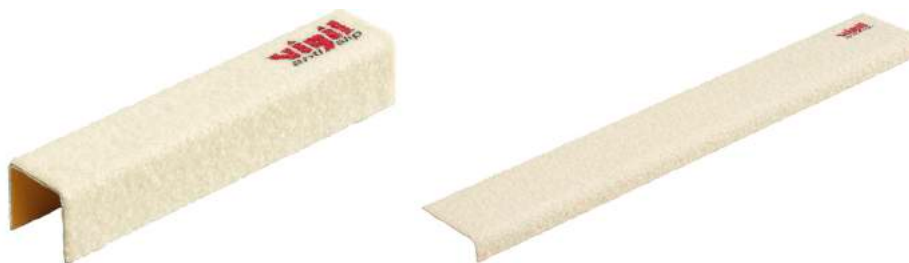





Test results

Mechanical stress resistance Height

Level KG·CM	1	2	3	4	5
Low	192	Cracking	No	No	No

Medium 196 No Cracking No No Cracking

High 200 No Cracking No Cracking Cracking

Test method ASTM D2794 - result: 196 Kg cm

22 Peel Road
O'CONNOR WESTERN AUSTRALIA 6163
TELEPHONE: + 618 9337 9811
FACSIMILE: +618 314 1972
email: vigil@vigilantislip.com
website: www.vigilantislip.com

WARRANTY NO:
CUSTOMER:
ORDER NO:
DATE:

WARRANTY

Prism Pty Ltd (A.B.N.: 54 009 342 910) warrants all Premium Quality **Vigil Antislip** products purchased on the above Order Number and date, for a period of (10 years) from the date of invoice.

It is warranted that all materials and workmanship utilised in the manufacture of Premium Quality Vigil Antislip products are of the highest quality and further more that these products will be:

- Resistant to wear under normal use and conditions
- Resistant to degradation from surface exposure to solvents
- Resistant to corrosion provided that Colorbond Steel-backed products are not installed in splash zones
- Resistant to delamination through thermal expansion inequities
- Resistant to delamination through impact except for the immediate impact zone

If the **Vigil Antislip** product fail to comply with the Warranty, Prism Pty Ltd shall replace such products at no cost to the Distributor or Customer within a period of 4 weeks after official notification.

Prism Pty Ltd assumes no liability for damage to Vigil Antislip products cause by improper treatment or if the product has been subject to abuse or incorrect installation.

Only original Warranty Certificates can be used for claim purposes.

S.R. McCorkill
 Managing Director

F.J. Hailstone
 Q.A. Manager

COMMON SEAL
 PRISM
 PTY LTD
 A.B.N. 54 009 342 910

Bleach (NaOCl)	14%							
Sulphuric acid	10%							
Nitric acid	30%							
Formic acid	10%							
Acetic acid	10%							
Lactic acid	5%							
Petrol (Tetraethyl lead fuel)	14%							
Toluene	14%							
Styrene	14%							
1.1.1-trichloroethane	14%							
Skydrol 500A (Hydraulic substance for airplanes)	14%							
Test period in weeks		1	2	3	4	5	6	7
		1	2	3	4	5	6	7

No deterioration Mild deterioration

Flammability Determination of	Average
Ignition time	5,78 min
Flame propagation time	0 s.
Integral heat emission	71,1 kJ/m ²
Smoke emission, log D	-0,8101
Optical density, D	0,1572/m

Flammability Result index	Result index	index
Ignition time	14	0 - 20
Flame spread index	0	0 - 10
Heat development index	2	0 - 10
Smoke development index	5	0 - 10

Determination of anti-slip behaviour			
Test method ASTM D4518			
Conditie	Resultaat	Resultaat	Resultaat
Dry	0,53	Commercial	R - 13
Wet	0,50	Industrial	R - 12
Oiled	0,49	Offshore	R - 12
Oiled after impact	0,41		

Determination aging properties		
Test method ISO 20340:2003 / TÜV SÜD		
Results		
ISO4628-2	No blistering	Rating 0 (S0)
ISO4628-3	No corrosion	Rating Ri 0
ISO4628-4	No cracking	Rating 0 (S0)
ISO4628-5	No flaking	Rating 0 (S0)
ISO4628-6	No powdering	Rating 0
Corrosion	No corrosion after scratching the surface.	

Adhesion test Tractive force 3MPa.

Determination sea water resistance		
Test method ISO 20340:2003 / TÜV SÜD		
Results		
ISO4628-2	No blistering	Rating 0 (S0)
ISO4628-3	No corrosion	Rating Ri 0
ISO4628-4	No cracking	Rating 0 (S0)
ISO4628-5	No flaking	Rating 0 (S0)
ISO4628-6	No powdering	Rating 0
Corrosion	Less than 1mm corrosion after scratching the surface.	

Adhesion test Tractive force 3MPa

Determination corrosion resistance	
Test method ISO 15711 / TÜV SÜD	
Results	
No anti-slip coating was detached, nor did any flaking or blistering occur on the anti-slip element. The result proves that the coating on the cathodic element is resistant against delamination and damage in the described circumstances.	

More Extensive technical information is available upon your request.



Montage

Installation advice

The guidelines below may be used to optimally install an anti-slip element on the desired surface. This is based on the most common situations/surfaces. If your situation/surface is different, please contact the Sales Department to receive a tailored advice.

Stair & bull nosings

For grate or perforated stair surfaces, installation must take place with an assembly kit consisting of a hexagon socket button head screw (M8x50mm), a saddle piece (mesh33) and a self-locking nut (M8). This assembly kits is available in either galvanised or stainless steel. The element must be pre-drilled with a 9mm diameter drill. The number of holes depends on the dimensions of the element. In case of a levelled concrete surface, the element can also be assembled using the SIKAFlex 291 adhesive.

Saddle Piece #33

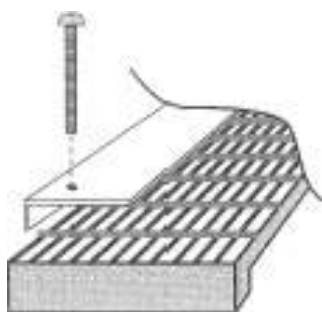

Tek Screw

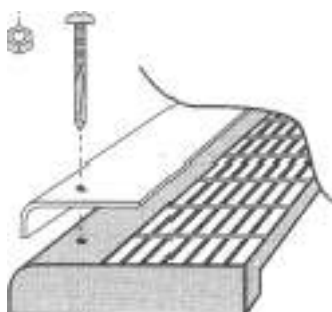

Metal deck

If the situation is not or barely mechanically stressed, it suffices to attach with an adhesive kit. For situations that are regularly mechanically stressed, for instance by traffic of forklifts or other heavy machinery, it is advised to mount with a countersunk screw (M6) and a plug connection (pre-drilling diameter 7mm). In case of a metal surface (steel, aluminium, stainless steel, etc.) the anti-slip element can be mounted using blind rivets (pre-drilling diameter 4-5mm) or self-tapping screws (M6) or a countersunk bolt and nut (pre-drilling diameter 7mm).

Ladder rung covers

Adhesion with the SIKAFlex 291A suffices.

Vinyl deck

In a situation with limited mechanical stress that uses Vinyl deck, full-surface gluing with a SIKAFlex 291 adhesive suffices. The same applies to a curved or hollow surface such as a tank vehicle.

In some situations it is advisable to combine the mechanical connection with a stroke of adhesive or kit.

References

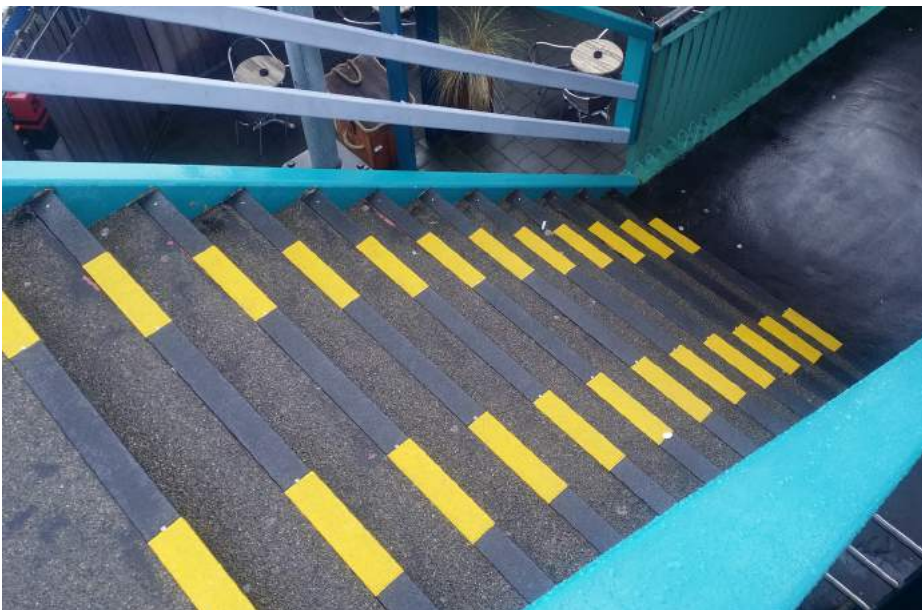
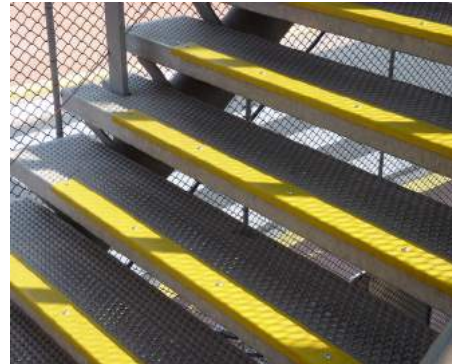
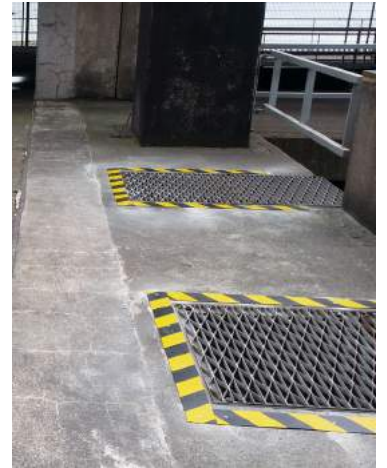

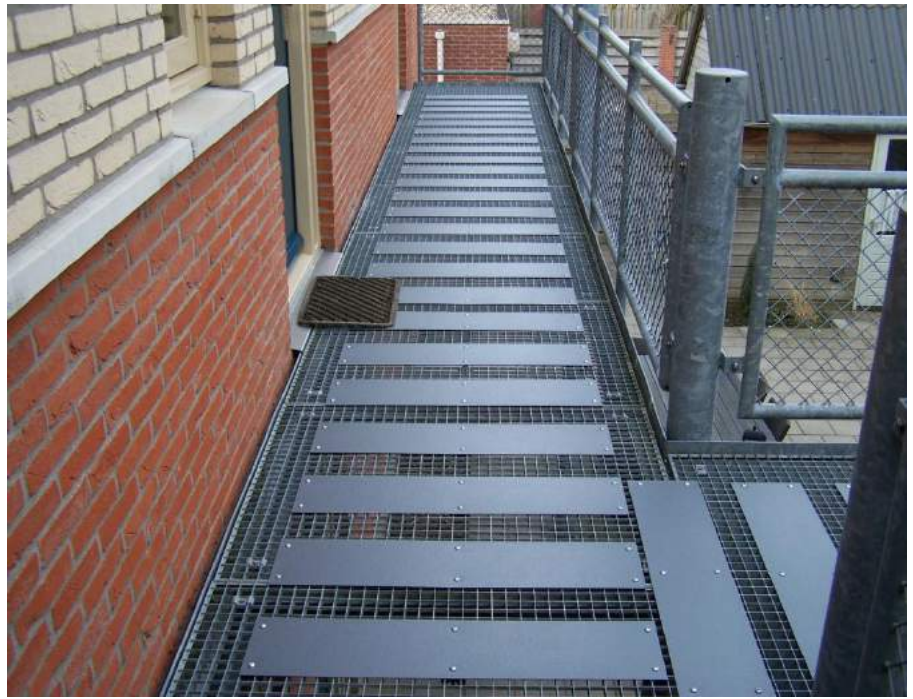

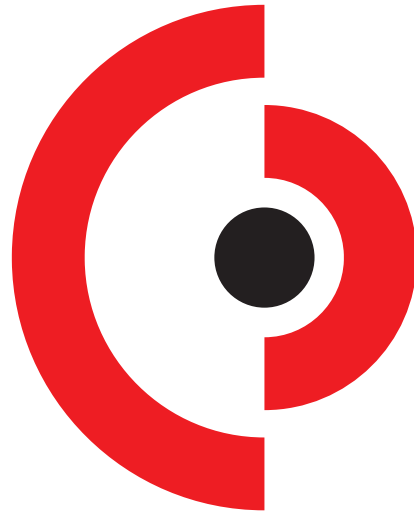

Haagh Protection BV

Dorpenbaan 8
5121 DG Rijen – The Netherlands
Tel: +31 (0)161 - 22 65 59
Fax: +31 (0)161 - 74 50 00
info@haagh-protection.com
www.haagh-protection.com

For more information about the Haagh Protection product portfolio, please contact us. Call us at: +31 (0)161 22 65 59 or send an e-mail to: info@haagh-protection.com.

Haagh Protection is specialised in various high-grade quality products that share the joint characteristic of creating a safe and pleasant workplace.

This brochure offers you an impression of our possibilities.

Also available in our product portfolio: VARIOGATE®

